

ZAKAŹENIE NR 12 DO SIK12  
PROJEKT ARANŻACJI SALI

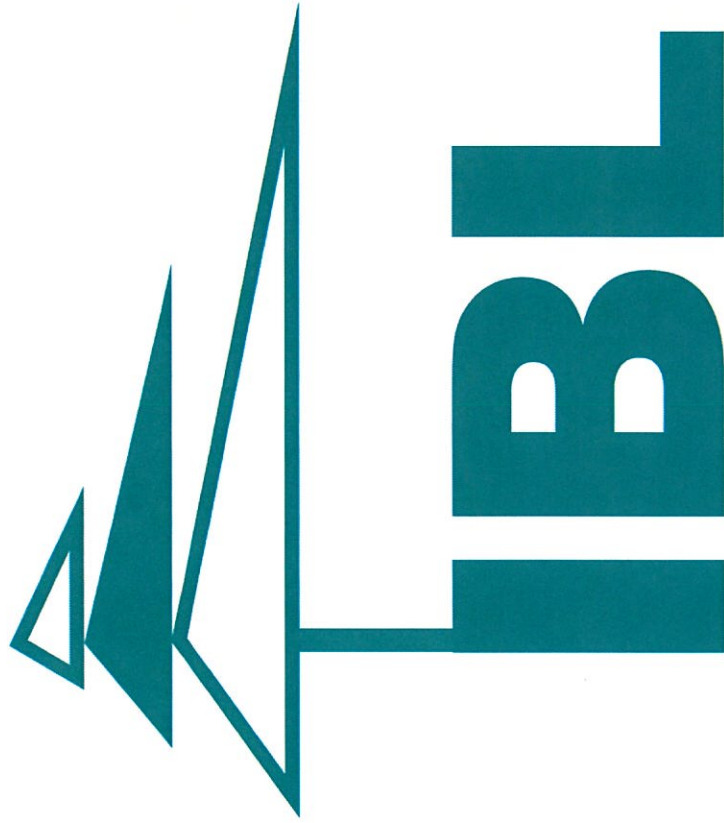

PROJEKT ARANŻACJI SALI LABORATORYJNEJ, SALI  
ZMYŚLÓW, POMIESZCZENIA TECHNICZNEGO

A small, handwritten mark or signature in blue ink, located at the bottom right of the page.

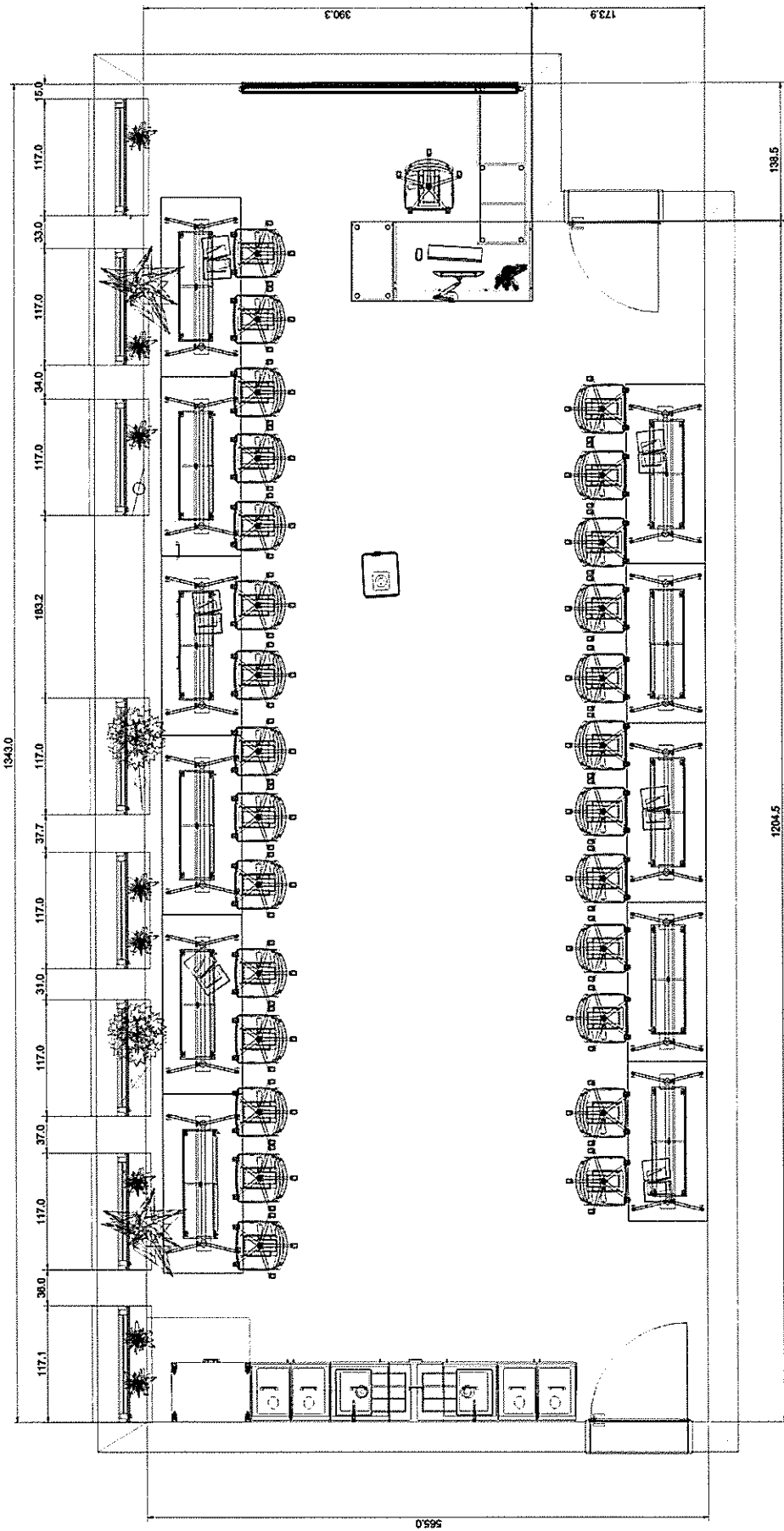

SALA LABORATORYJNA

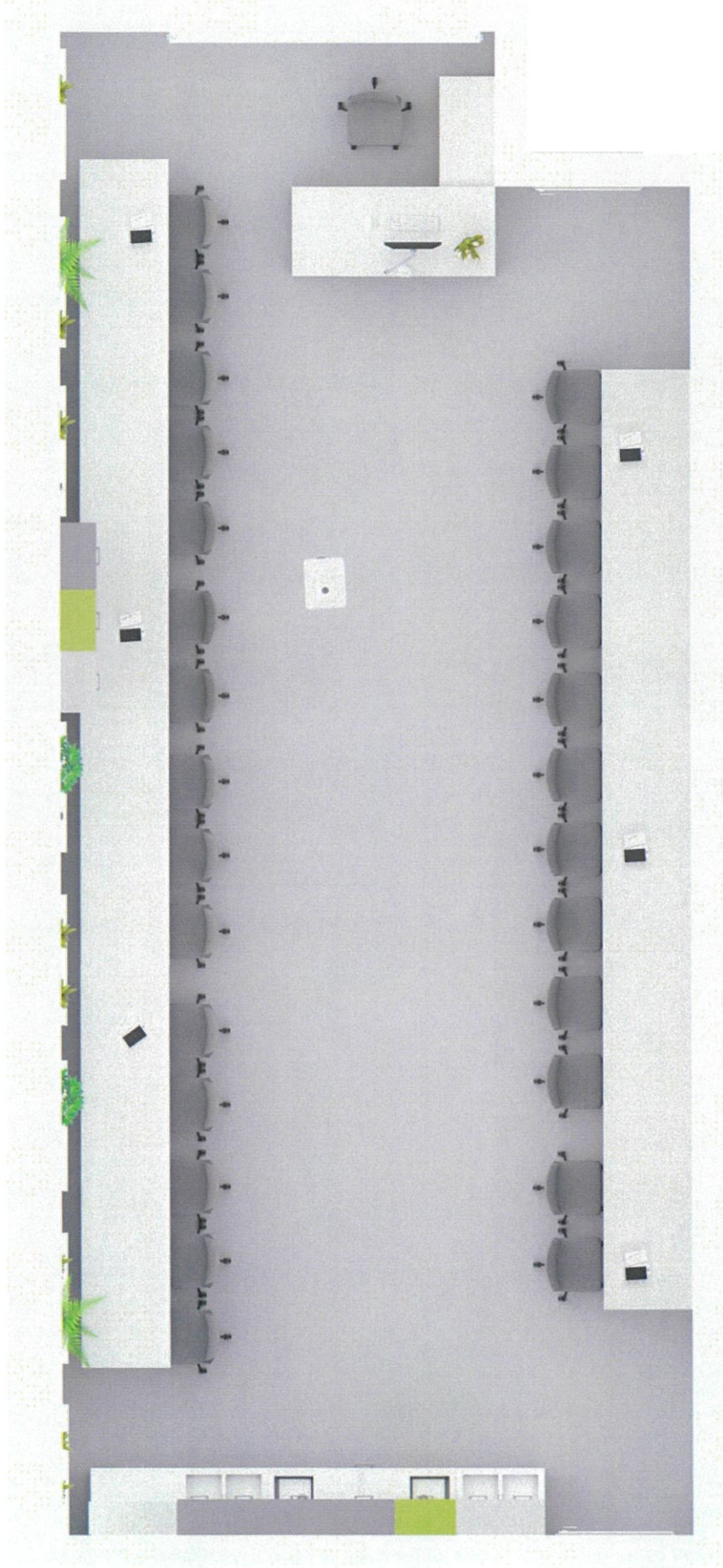

SALA LABORATORYJNA

A handwritten signature in blue ink, consisting of a stylized 'G' followed by a flourish.

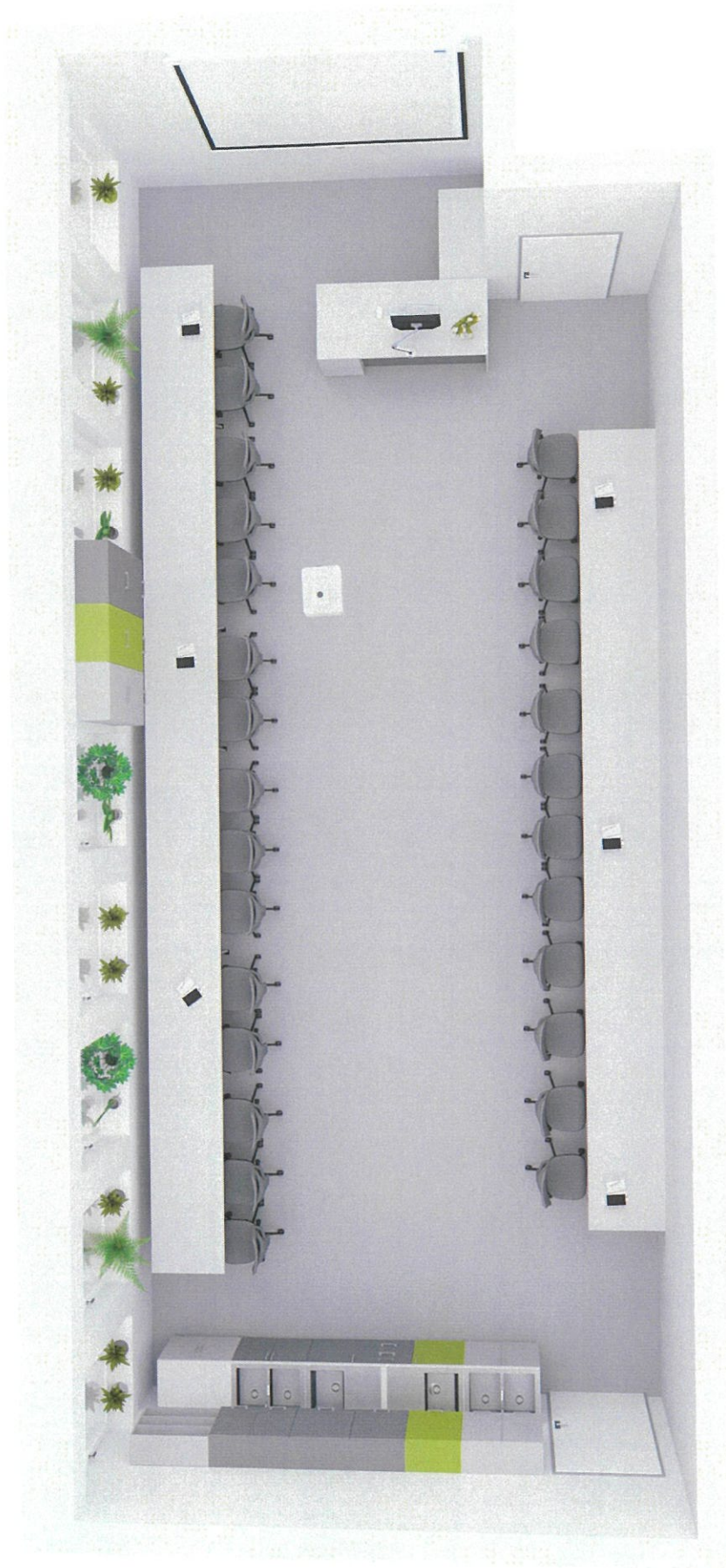

SALA LABORATORYJNA

*Handwritten signature or mark.*



SALA LABORATORYJNA

GF



SALA LABORATORYJNA

A handwritten signature in blue ink, located at the bottom right of the page.









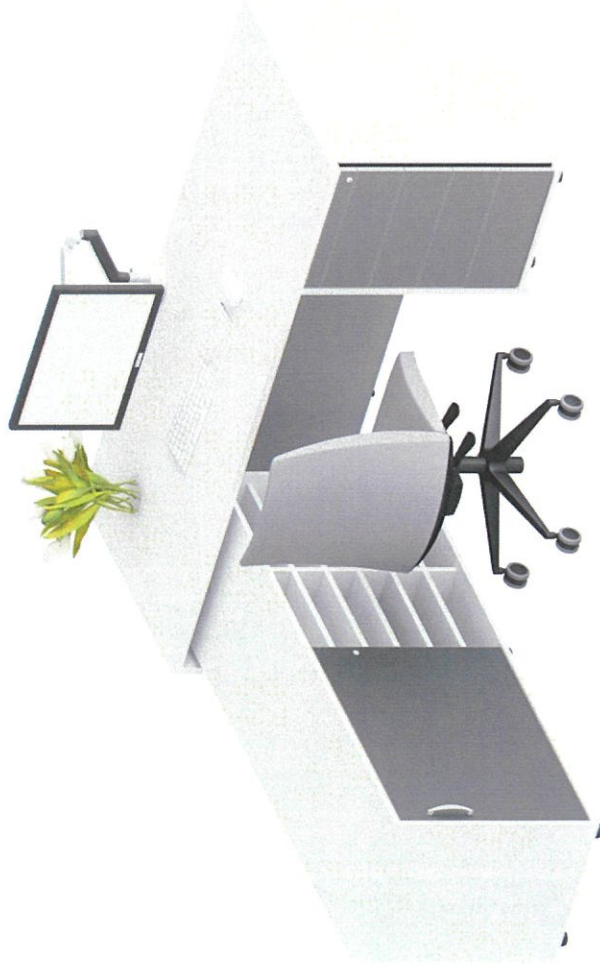

WIZUALIZACJA LADY – SALA LABORATORYJNA

A handwritten signature or logo in blue ink, consisting of a stylized, cursive letter 'G'.

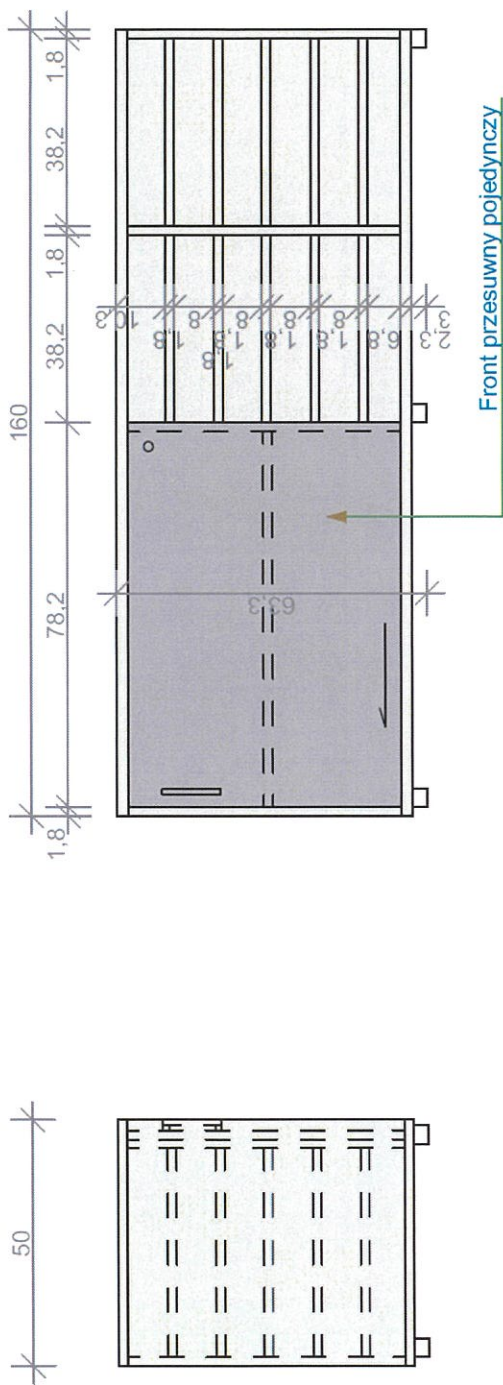

**SZAFKA POD LADEĘ – SALA LABORATORYJNA**

9-

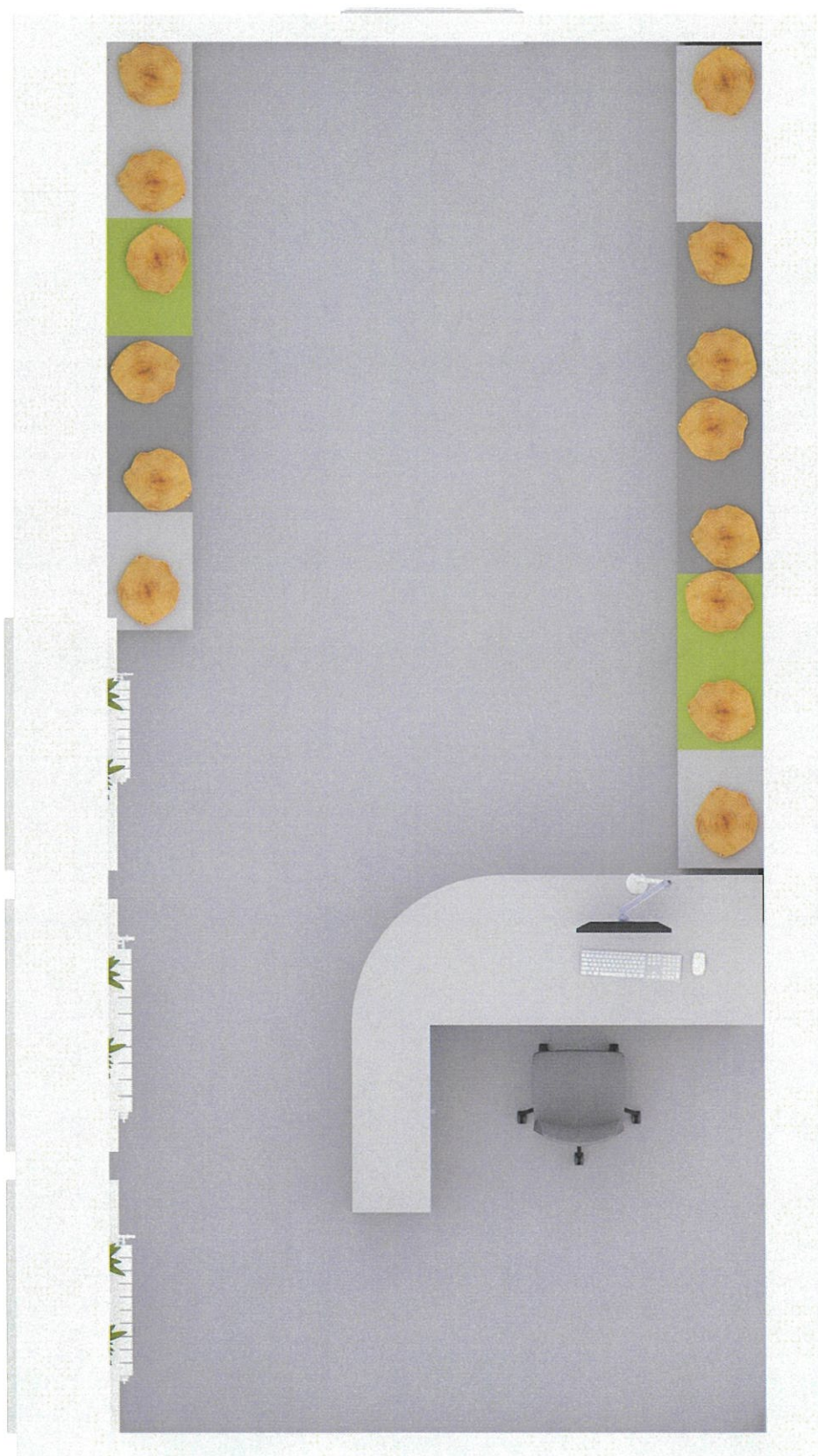

SALA ZMYŚLÓW RZUT 2D KOLOR

g



SALA ZMYŚLÓW RZUT 3D KOLOR

A handwritten signature in blue ink, consisting of stylized, cursive letters.



SALA ZMYŚLÓW WIZUALIZACJA

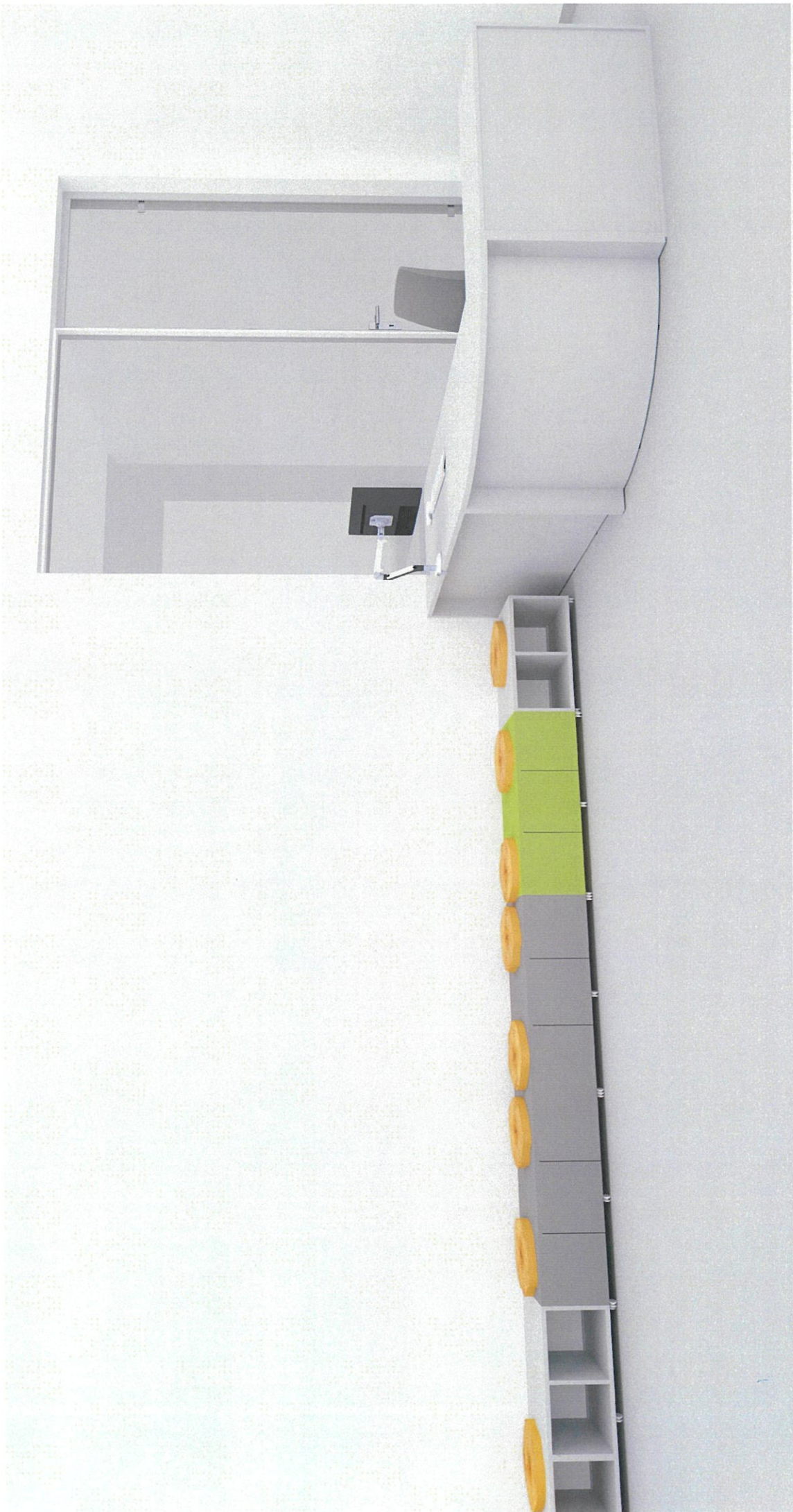

SALA ZMYŚLÓW WIZUALIZACJA



SALA ZMYŚLÓW WIZUALIZACJA



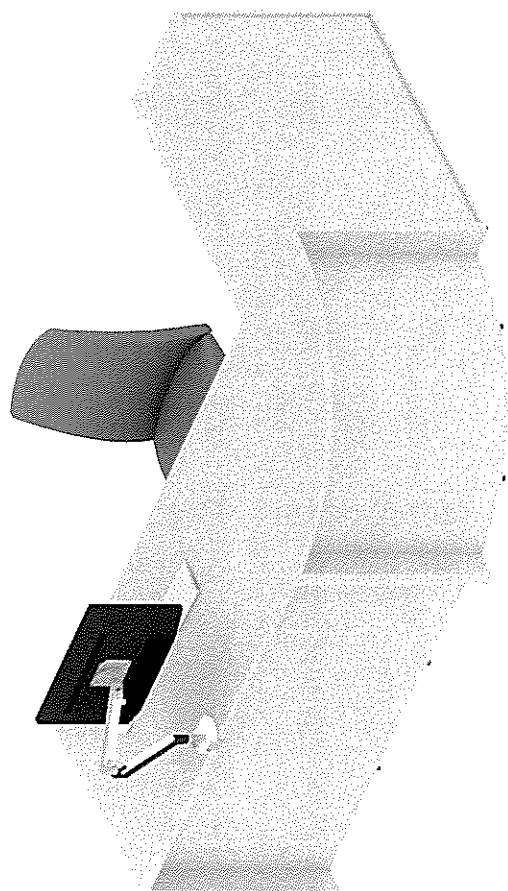
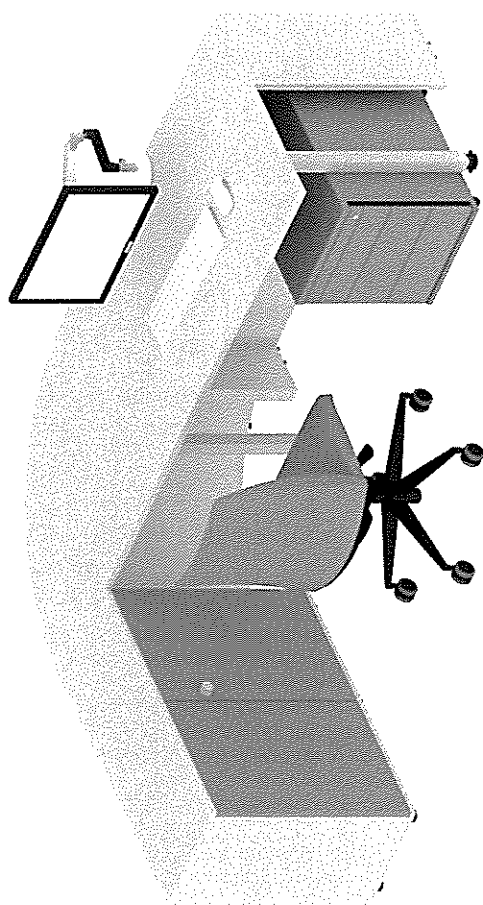

WIZUALIZACJA LADY – SALA ZMYŚLÓW

9-

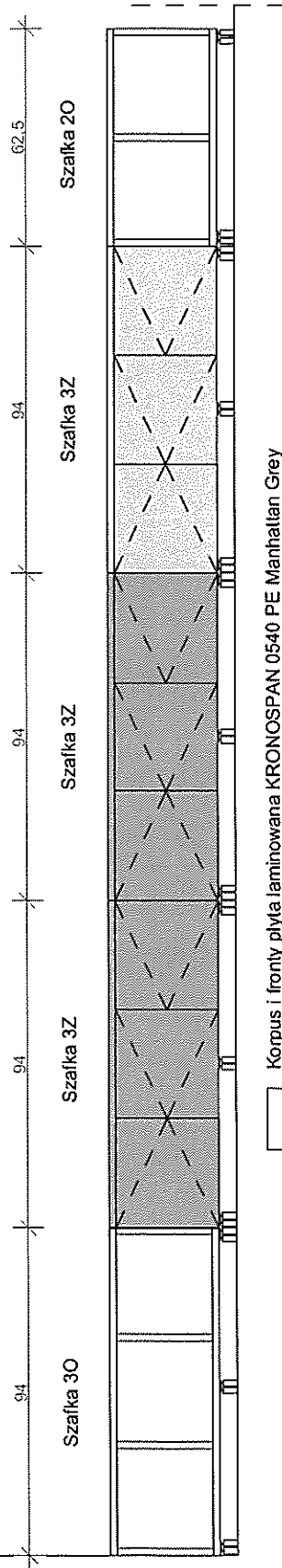
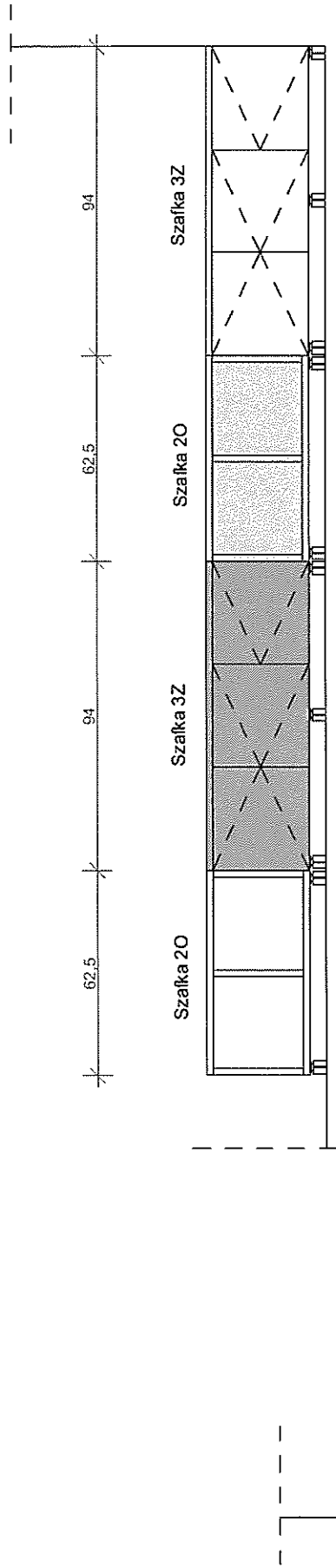

Korpus i fronty płyta laminowana KRONOSPAN 0540 PE Manhattan Grey

Korpus i fronty płyta laminowana KRONOSPAN 0171 PE Slate Grey

Korpus i fronty płyta laminowana 8996 BS Ocean Green

Uchwyty tip-on, zawiasy BLUM z cichym domykiem, plecy pełne 18 cm

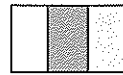

Szafki mobilne widok ustawienia

**PROJEKT SZAFEK MOBILNYCH Z MOŻLIWOŚCIĄ SIEDZENIA – SALA ZMYŚLÓW**

Handwritten signature.





**POMIESZCZENIE TECHNICZNE – WIZUALIZACJA**



POMIESZCZENIE TECHNICZNE – WIZUALIZACJA





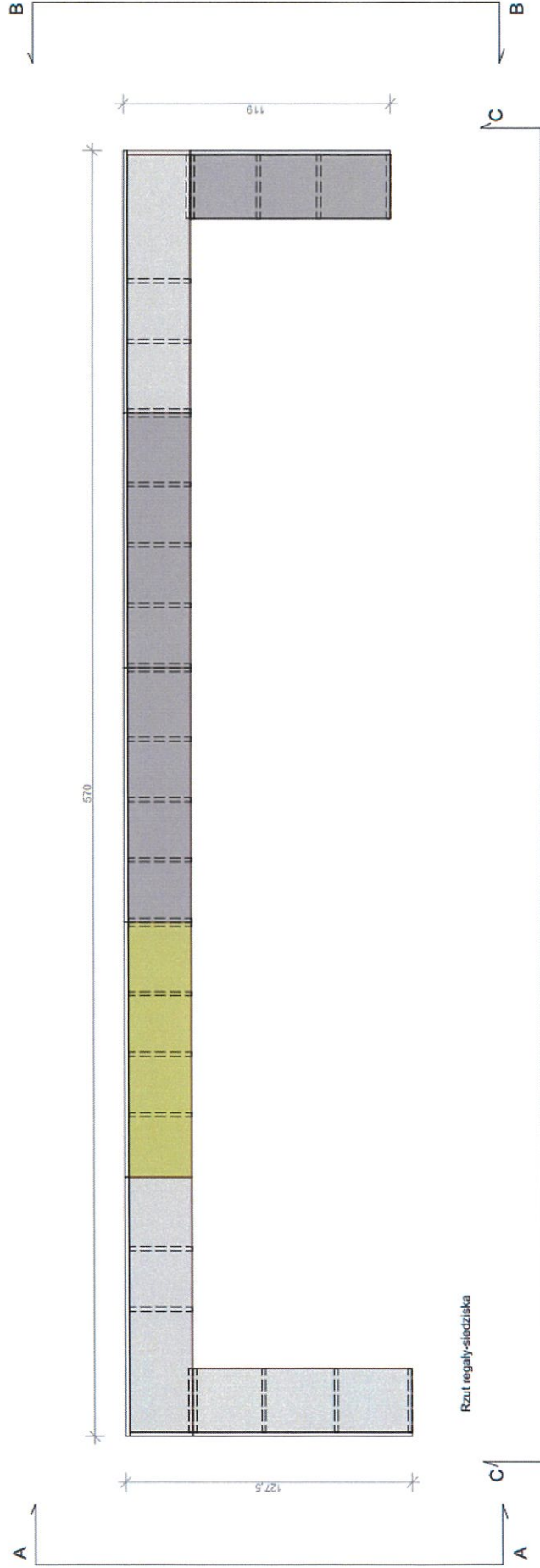
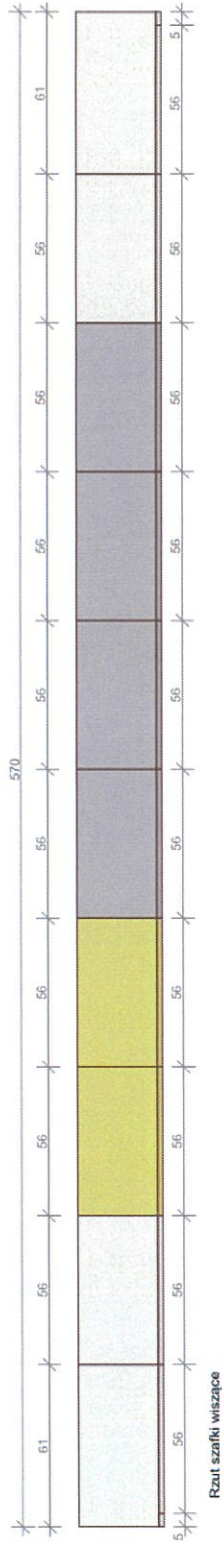

CP



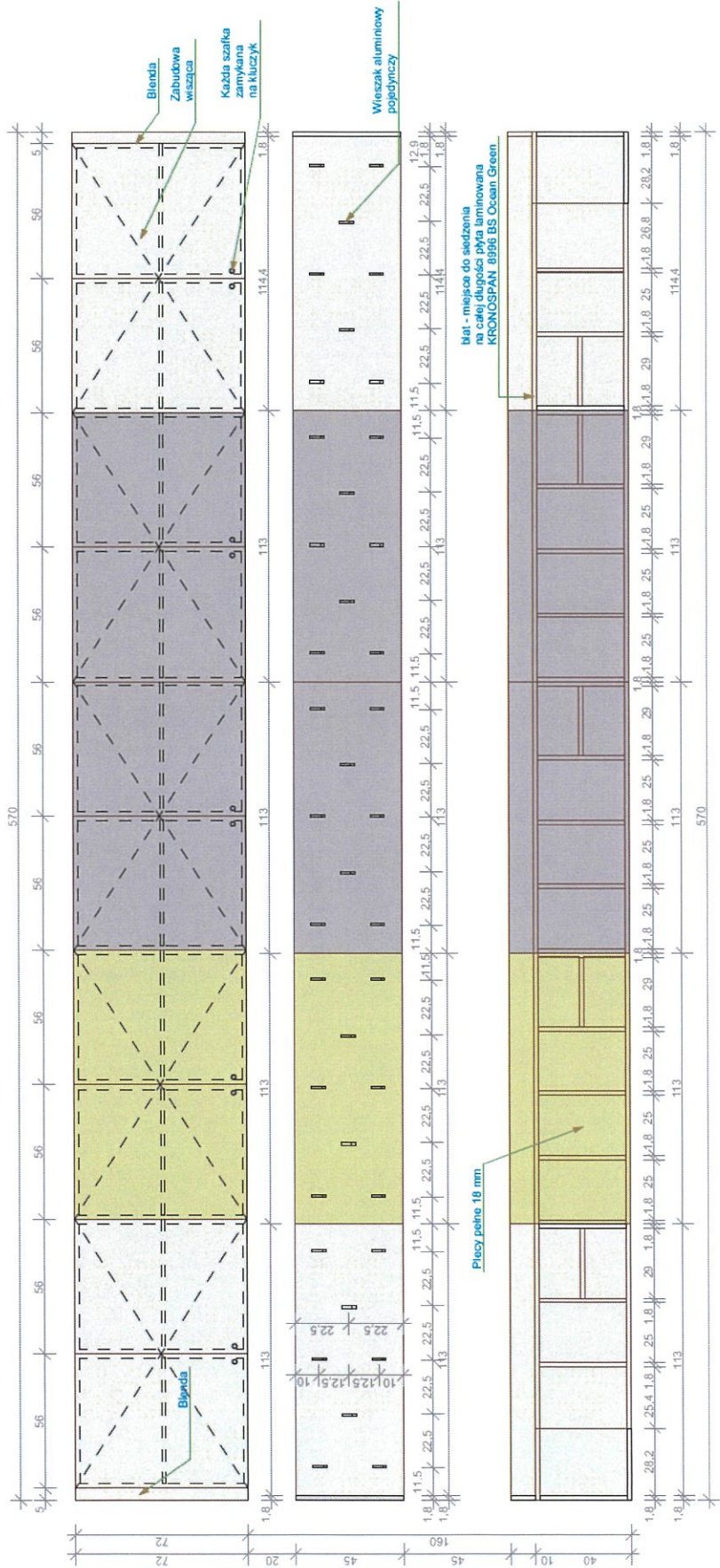

Widok C-C

- Korpus i fronty płyta laminowana KRONOSPAN 0540 PE Manhattan Grey
  - Korpus i fronty płyta laminowana KRONOSPAN 8996 BS Ocean Green
  - Korpus i fronty płyta laminowana KRONOSPAN 0171 PE Slate Grey
- Uchwyt typ-on, szafka wisząca zamykana na kluczyk, zawiasy BLUM z cichym domykiem

**POMIESZCZENIE TECHNICZNE – PROJEKT SZAFEK NA OBUWIE, WIESZAKÓW I ZABUDOWY WISZĄCEJ**



